

General Warranty

We warrant that the product will be free from defects in materials and workmanship for a period of 3 years from the date of purchase of the product by the original purchaser from the our Company. The warranty period for accessories such as probes, adapter is 12 months. This warranty only applies to the original purchaser and is not transferable to a third party.

If the product proves defective during the warranty period, we will either repair the defective product without charge for parts and labour, or will provide a replacement in exchange for the defective product. Parts, modules and replacement products used by our company for warranty work may be new or reconditioned like new. All replaced parts, modules and products become the property of our company.

In order to obtain service under this warranty, the customer must notify our company of the defect before the expiration of the warranty period. Customer shall be responsible for packaging and shipping the defective product to the designated service centre, a copy of the customers proof of purchase is also required.

This warranty shall not apply to any defect, failure or damage caused by improper use or improper or inadequate maintenance and care. We shall not be obligated to furnish service under this warranty a) to repair damage resulting from attempts by personnel other than our company representatives to install, repair or service the product; b) to repair damage resulting from improper use or connection to incompatible equipment; c) to repair any damage or malfunction caused by the use of not our supplies; or d) to service a product that has been modified or integrated with other products when the effect of such modification or integration increases the time or difficulty of servicing the product.

Please contact the nearest Sales and Service Offices for services or a complete copy of the warranty statement.

Excepting the after-sales services provided in this summary or the applicable warranty statements, we will not offer any guarantee for maintenance definitely declared or hinted, including but not limited to the implied guarantee for marketability and special-purpose acceptability. We should not take any responsibilities for any indirect, special or consequent damages.

Table of Contents

1. General Safety Requirements	1
2. Safety Terms and Symbols	2
3. Quick Start	4
Introduction to the Structure of the Oscilloscope	4
Front Panel	4
Side Panel.....	5
Top Panel	6
User Interface Introduction	6
How to Implement the General Inspection	8
How to Implement the Function Inspection	8
How to Implement the Probe Compensation	9
How to Set the Probe Attenuation Coefficient	10
How to Use the Probe Safely	11
How to Implement Self-calibration	12
Introduction to the Vertical System	12
Introduction to the Horizontal System	13
Introduction to the Trigger System	14
Touchscreen Controls	14
How to Measure Automatically	19
How to Use Autoscale	20
4. Communication with PC	20
Using USB Port	20
Using LAN Port	21
Connect directly	21
Connect through a router.....	23
Using Wi-Fi to Connect with PC (Optional)	25
Connect with PC as Wi-Fi Access Point	25
Connect with PC as Wi-Fi Station	26
5. Use the Multimeter	29
Input Terminals	29
DMM Menu	29
DMM Information Window	30
6. Communication with Android Device via Wi-Fi (Optional)	31

How to Connect	31
Connect with APP as Wi-Fi Access Point	31
Connect with APP as Wi-Fi Station	33
7. Appendix	35
Appendix A: Enclosure	35
Appendix B: General Care and Cleaning	35
Appendix C: USB Disk Requirements	36

1. General Safety Requirements

Before use, please read the following safety precautions to avoid any possible bodily injury and to prevent this product or any other connected products from damage. In order to avoid any contingent danger, ensure this product is only used within the range specified.

Only the qualified technicians can implement the maintenance.

To avoid Fire or Personal Injury:

- **Connect the probe correctly.** The grounding end of the probe corresponds to the grounding phase. Please don't connect the grounding end to the positive phase.
- **Use Proper Power Cord.** Use only the power cord supplied with the product and certified to use in your country.
- **Connect or Disconnect Correctly.** When the probe or test lead is connected to a voltage source, please do not connect and disconnect the probe or test lead at random.
- **Product Grounded.** This instrument is grounded through the power cord grounding conductor. To avoid electric shock, the grounding conductor must be grounded. The product must be grounded properly before any connection with its input or output terminal.

When powered by AC power, it is not allowed to measure AC power source directly, because the testing ground and power cord ground conductor are connected together, otherwise, it will cause short circuit.

When powered by battery, the product must ground connection. To avoid electric shock, there must be a ground wire connect between ground and the ground port (on the back of product panel).

- **Check all Terminal Ratings.** To avoid fire or shock hazard, check all ratings and markers of this product. Refer to the user's manual for more information about ratings before connecting to the instrument.
- **Do not operate without covers.** Do not operate the instrument with covers or panels removed.
- **Use Proper Fuse.** Use only the specified type and rating fuse for this instrument.
- **Avoid exposed circuit.** Do not touch exposed junctions and components when the instrument is powered.
- **Do not operate if in any doubt.** If you suspect damage occurs to the instrument, have it inspected by qualified service personnel before further operations.
- **Use your Oscilloscope in a well-ventilated area.** Make sure the instrument installed with proper ventilation, refer to the user manual for more details.
- **Do not operate in wet conditions.**
- **Do not operate in an explosive atmosphere.**
- **Keep product surfaces clean and dry.**

2. Safety Terms and Symbols

Safety Terms

Terms in this manual. The following terms may appear in this manual:

 **Warning:** Warning indicates the conditions or practices that could result in injury or loss of life.

 **Caution:** Caution indicates the conditions or practices that could result in damage to this product or other property.

Terms on the product. The following terms may appear on this product:

Danger: It indicates an injury or hazard may immediately happen.

Warning: It indicates an injury or hazard may be accessible potentially.

Caution: It indicates a potential damage to the instrument or other property might occur.

Safety Symbols

Symbols on the product. The following symbol may appear on the product:

 Hazardous Voltage

 Refer to Manual

 Protective Earth Terminal

 Chassis Ground

 Test Ground

To avoid body damage and prevent product and connected equipment damage, carefully read the following safety information before using the test tool. This product can only be used in the specified applications.

 **Warning:**

The two channels of the oscilloscope are not electrically isolated. The channels should adopt a common ground during measuring. To prevent short circuits, the 2 probe grounds must not be connected to 2 different non-isolated DC levels.

The diagram of the oscilloscope ground wire connection:

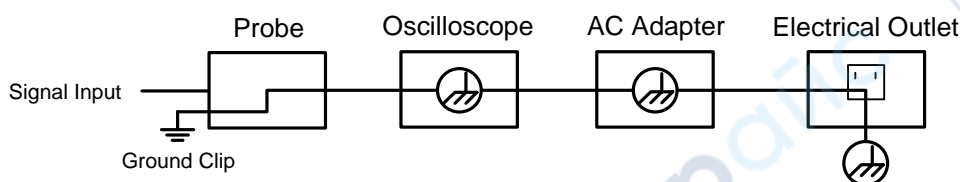

The diagram of the ground wire connection when the battery-powered oscilloscope is connected to the AC-powered PC through the ports:

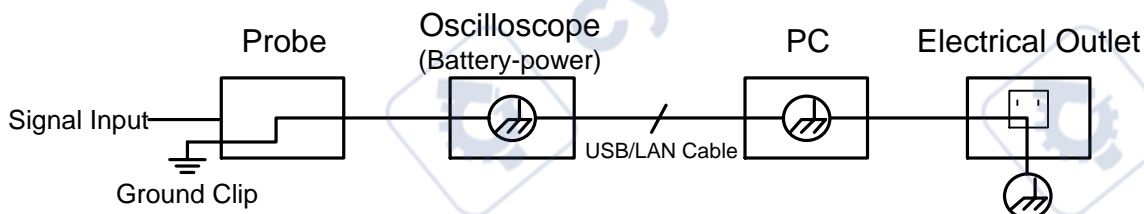

It is not allowed to measure AC power when the oscilloscope is AC powered, or when the battery-powered oscilloscope is connected to the AC-powered PC through the ports.

⚠ Warning:

To avoid fire or electrical shock, when the oscilloscope input signal connected is more than 42V peak (30Vrms) or on circuits of more than 4800VA, please take note of below items:

- Only use accessory insulated voltage probes and test lead.
- Check the accessories such as probe before use and replace it if there are any damages.
- Remove probes, test leads and other accessories immediately after use.
- Remove USB cable which connects oscilloscope and computer.
- Do not apply input voltages above the rating of the instrument because the probe tip voltage will directly transmit to the oscilloscope. Use with caution when the probe is set as 1:1.
- Do not use exposed metal BNC or banana plug connectors.
- Do not insert metal objects into connectors.

3. Quick Start

Introduction to the Structure of the Oscilloscope

This chapter makes a simple description of the operation and function of the oscilloscope, enabling you to be familiar with the use of the oscilloscope in the shortest time.

Front Panel

The front panel has knobs and function buttons. Through the function buttons, you can enter different function menus or obtain a specific function application directly.

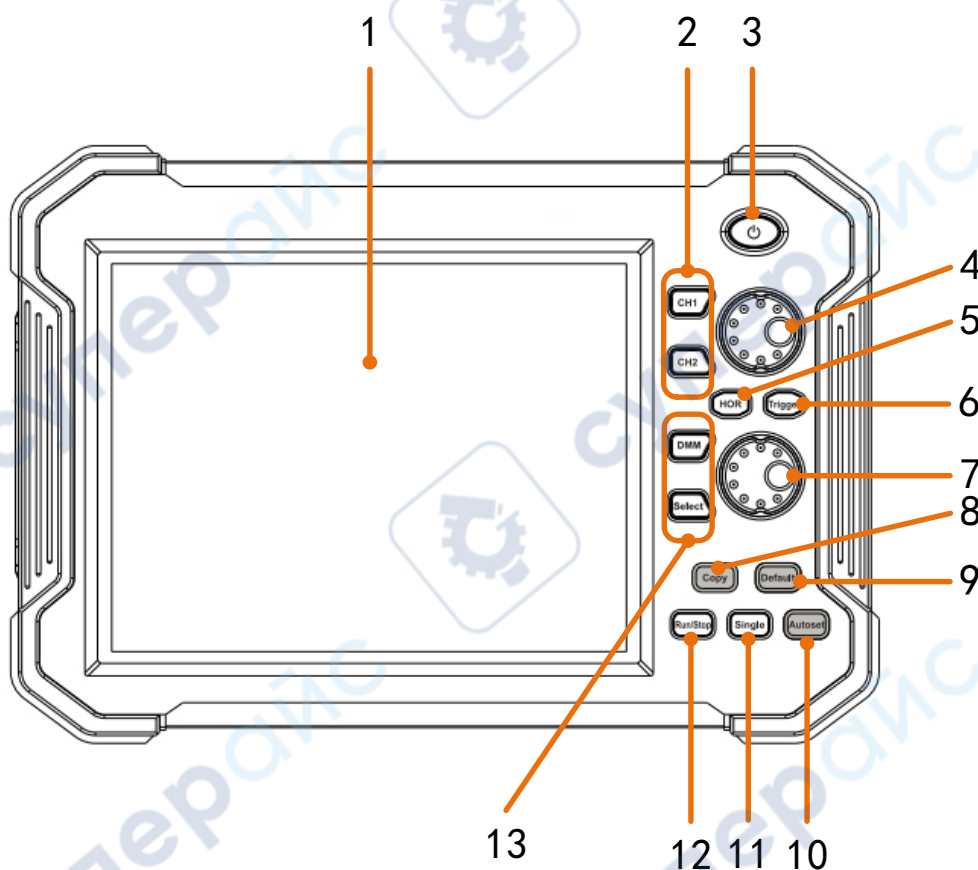



Figure 3-1 Front panel

1. LCD touchscreen
2. **CH1 – CH2** buttons: Access to setting menu of CH1 – CH2.
3. **Power** button: Power on/off
4. The **A** knob:
When one of the **CH1 – CH2** buttons is lighted, this knob is used to adjust the vertical position of current channel,
When **HOR** button is lighted, this knob is used to adjust the horizontal positions of all channels (including mathematical operations).
When **Trigger** button is lighted, this knob is used to adjust trigger level.
5. **HOR** button: When the button light is off, press to light on, the **A** and **B** knob are for horizontal system. Press to switch between the normal mode and the waveform

zooming mode.

6. **Trigger** button: Accesses to trigger system setting. When the button light is on, the **A** knob is used to adjust trigger level of current channel.
7. The **B** knob:
 - When one of the **CH1 – CH2** buttons is lighted, this knob is used to adjust the voltage scale of current channel.
 - When **HOR** button is lighted, this knob is used to adjust time base.
8. **Copy** button: You can save the waveform by just pushing this button in any user interface. The source wave and the storage location are set in the **Save** menu when the Type is **Wave** ( → **Save**).
9. **Default** button: Press this button, a prompt will show, press again to execute the factory settings.
10. **Autoset** button: Quick way to apply a set of pre-set functions to the incoming signal, and display the best possible viewing waveform of the signal.
11. **Single** button: Set the trigger mode as single directly.
12. **Run/Stop** button: Enable or disable sampling on input signals.
13. **DMM** button : Quickly On/Off DMM and measure parameter switch button.
 - Select: Switch between AC and DC when measuring voltage or current; and switch resistance, continuity, diode, and capacitance measurement when selecting other.

Side Panel

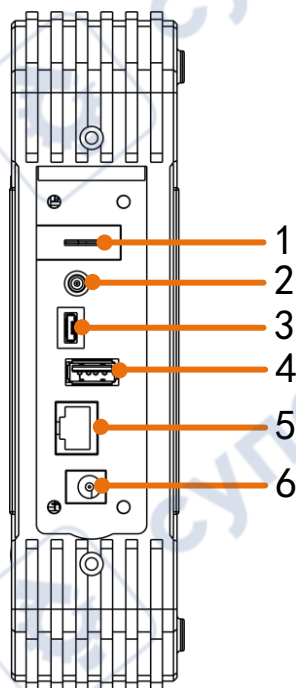



Figure 3-2 Rear Panel

1. **Probe Compensation**: Measurement signal (5V/1kHz) output.
2. **Trig Out or Pass/Fail** output connector: Trigger signal output or Pass/Fail output. The output type can be set on the menu ( → Utility → Function → Output → Output).
3. **USB Device port**: It is used to transfer data when external USB equipment connects to

the oscilloscope regarded as "slave device". For example: to use this port when connect PC to the oscilloscope by USB.

4. **USB Host port:** It is used to transfer data when external USB equipment connects to the oscilloscope regarded as "host device". For example: Saving the waveform to USB flash disk needs to use this port.
5. **LAN port:** the network port which can be used to connect with PC.
6. Connector for the DC power source via an AC-DC adapter

Top Panel

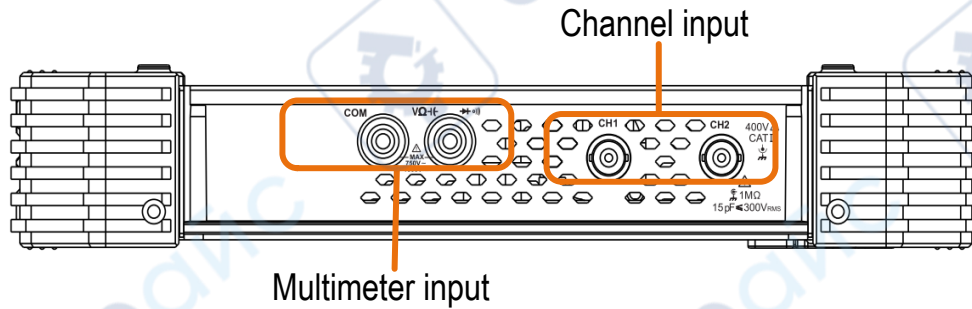

Figure 3-3 Top Panel Overview

User Interface Introduction

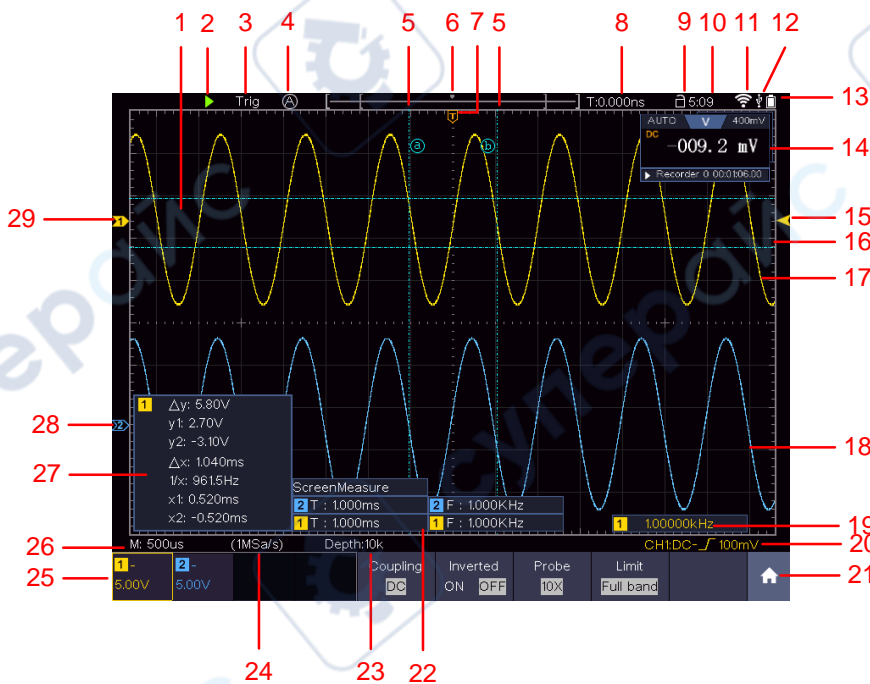

Figure 3-4 Illustrative Drawing of Display Interfaces

1. Waveform Display Area.
2. Run/Stop (touchable)
3. The state of trigger, including:



Auto: Automatic mode and acquire waveform without triggering.

Trig: Trigger detected and acquire waveform.

Ready: Pre-triggered data captured and ready for a trigger. Click the **Ready** to force a trigger signal, which is mainly applied to the "Normal" and "Single" trigger modes.

Scan: Capture and display the waveform continuously.

Stop: Data acquisition stopped.

4. Click to auto set.
5. The two blue dotted lines indicates the vertical position of cursor measurement.
6. The pointer indicates the trigger position in the record length.
7. The T pointer indicates the horizontal position for the trigger.
8. It shows present triggering value and displays the site of present window in internal memory.
9. Touchable icon is to enable () or disable () the touchscreen controls.
10. It shows setting time.
11. Wi-Fi is activated.
12. It indicates that there is a USB disk connecting with the oscilloscope.
13. Indicating battery power status.
14. Multimeter window.
15. The waveform of CH1.
16. The pointer shows the trigger level position of the source in trigger menu.
17. The two blue dotted lines indicate the horizontal position of cursor measurement.
18. The waveform of CH2.
19. The frequency of the trigger signal.
20. The icon shows the selected trigger type, e.g.  represents triggering on the rising edge for an Edge trigger. The reading shows the trigger level value of the corresponding channel.
21. Click to show/hide the touchable menu pane.
22. It indicates the measured type and value of the corresponding channel. "**T**" means period, "**F**" means frequency, "**V**" means the average value, "**Vp**" the peak-peak value, "**Vr**" the root-mean-square value, "**Ma**" the maximum amplitude value, "**Mi**" the minimum amplitude value, "**Vt**" the Voltage value of the waveform's flat top value, "**Vb**" the Voltage value of the waveform's flat base, "**Va**" the amplitude value, "**Os**" the overshoot value, "**Ps**" the Preshoot value, "**RT**" the rise time value, "**FT**" the fall time value, "**PW**" the +width value, "**NW**" the -Width value, "**+D**" the +Duty value, "**-D**" the -Duty value, "**WP**" the Screen Duty, "**FRR**" the FRR, "**FRF**" the FRF, "**FFR**" the FFR, "**FFF**" the FFF, "**LRR**" the, "**LRF**" the LRF, "**LFR**" the LFR, "**LFF**" the LFF, "**PD**" the Delay A→B $\frac{\mu s}{\mu s}$ value, "**ND**" the Delay A→B $\frac{\mu s}{\mu s}$ value, "**TR**" the Cycle RMS, "**CR**" the Cursor RMS, "**RP**" the Phase A→B $\frac{\mu s}{\mu s}$, "**FP**" the Phase A→B $\frac{\mu s}{\mu s}$, "**+PC**" the +Pulse count, "**-PC**" the - Pulse count, "**+E**" the Rise edge count, "**-E**" the Fall edge count, "**AR**" the Area, "**CA**" the Cycle area.

23. The readings show the record length.
24. The readings show current sample rate.
25. The readings indicate the corresponding Voltage Division of the channels.
"BW" indicates bandwidth limit.
The icon shows the coupling mode of the channel.
"—" indicates direct current coupling
"~" indicates AC coupling
" \perp " indicates GND coupling
26. The reading shows the setting of main time base.
27. It is cursor measure window, showing the absolute values and the readings of the cursors.
28. The blue pointer indicates the grounding datum point (zero point position) of the waveform of the CH2 channel.
29. The yellow pointer indicates the grounding datum point (zero point position) of the waveform of the CH1 channel.

How to Implement the General Inspection

After you get a new oscilloscope, it is recommended that you should make a check on the instrument according to the following steps:

1. Check whether there is any damage caused by transportation.

If it is found that the packaging carton or the foamed plastic protection cushion has suffered serious damage, do not throw it away first till the complete device and its accessories succeed in the electrical and mechanical property tests.

2. Check the Accessories

The supplied accessories have been already described in the "Appendix A: Enclosure" of this Manual. You can check whether there is any loss of accessories with reference to this description. If it is found that there is any accessory lost or damaged, please get in touch with our distributor responsible for this service or our local offices.

3. Check the Complete Instrument

If it is found that there is damage to the appearance of the instrument, or the instrument can not work normally, or fails in the performance test, please get in touch with our distributor responsible for this business or our local offices. If there is damage to the instrument caused by the transportation, please keep the package. With the transportation department or our distributor responsible for this business informed about it, a repairing or replacement of the instrument will be arranged by us.

How to Implement the Function Inspection

Make a fast function check to verify the normal operation of the instrument, according to the following steps:

1. **Long press the  button on the top right of the instrument.**

The instrument carries out all self-check items and shows the Boot Logo. Push the **Default** button on the front panel. The default attenuation coefficient set value of the probe on the menu is 10X.

2. **Set the Switch in the Oscilloscope Probe as 10X and Connect the Oscilloscope with CH1 Channel.**

Align the slot in the probe with the plug in the CH1 connector BNC, and then tighten the probe with rotating it to the right side.

Connect the probe tip and the ground clamp to the connector of the probe compensator.

3. **Push the Autoset button on the front panel.**

The square wave of 1 kHz frequency and 5V peak-peak value will be displayed in several seconds (see *Figure 3-5*).

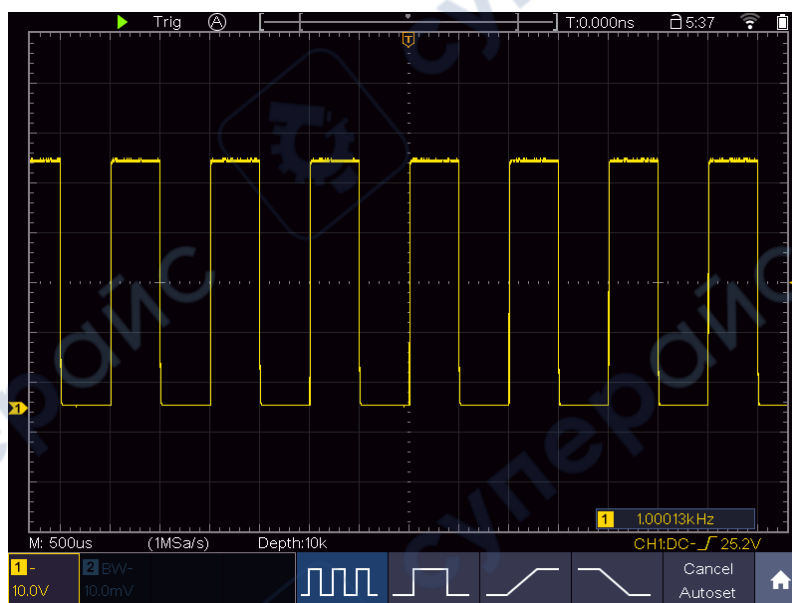

Figure 3-5 Auto set

Check CH2 by repeating Step 2 and Step 3.

How to Implement the Probe Compensation

When connect the probe with any input channel for the first time, make this adjustment to match the probe with the input channel. The probe which is not compensated or presents a compensation deviation will result in the measuring error

or mistake. For adjusting the probe compensation, please carry out the following steps:

1. Set the attenuation coefficient of the probe on the menu as 10X and that of the switch in the probe as 10X (see "*How to Set the Probe Attenuation Coefficient*" on P10), and connect the probe with the CH1 channel. If a probe hook tip is used, ensure that it keeps in close touch with the probe. Connect the probe tip with the signal connector of the probe compensator and connect the reference wire clamp with the ground wire connector of the probe connector, and then push the **Autoset** button on the front panel.
2. Check the displayed waveforms and regulate the probe till a correct compensation is achieved (see *Figure 3-6* and *Figure 3-7*).



Overcompensated Compensated correctly Under compensated

Figure 3-6 Displayed Waveforms of the Probe Compensation

3. Repeat the steps mentioned if needed.

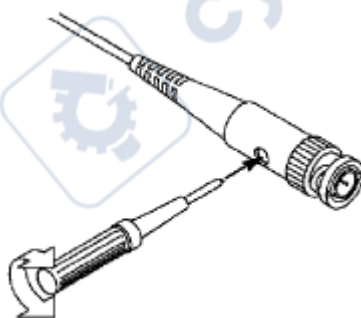

Figure 3-7 Adjust Probe

How to Set the Probe Attenuation Coefficient

The probe has several attenuation coefficients, which will influence the vertical scale factor of the oscilloscope.

To change or check the probe attenuation coefficient on the menu of oscilloscope:

- (1) Push the function menu button of the used channels (**CH1 – CH2** button).
- (2) Select **Probe** in the bottom menu; select **Attenu** in the right menu, select the proper value corresponding to the probe in the left menu.

This setting will be valid all the time before it is changed again.



Caution:

The default attenuation coefficient of the probe on the instrument is preset to 10X.

Make sure that the set value of the attenuation switch in the probe is the same as the menu selection of the probe attenuation coefficient in the oscilloscope.

The set values of the probe switch are 1X and 10X (see *Figure 3-8*).

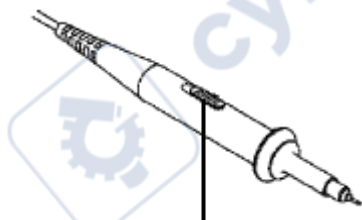

Figure 3-8 Attenuation Switch



Caution:

When the attenuation switch is set to 1X, the probe will limit the bandwidth of the oscilloscope in 5MHz. To use the full bandwidth of the oscilloscope, the switch must be set to 10X.

How to Use the Probe Safely

The safety guard ring around the probe body protects your finger against any electric shock, shown as *Figure 3-9*.

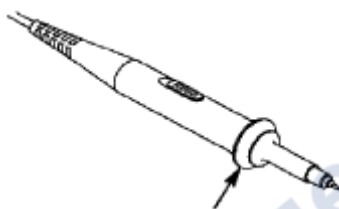

Figure 3-9 Finger Guard



Warning:

To avoid electric shock, always keep your finger behind the safety guard ring of the probe during the operation.

To protect you from suffering from the electric shock, do not touch any metal part of the probe tip when it is connected to the power supply.

Before making any measurements, always connect the probe to the instrument and connect the ground terminal to the earth.

How to Implement Self-calibration

The self-calibration application can make the oscilloscope reach the optimum condition rapidly to obtain the most accurate measurement value. You can carry out this application program at any time. This program must be executed whenever the change of ambient temperature is 5 °C or over.

Before performing a self-calibration, disconnect all probes or wires from the input connector. Click the  icon, select the **Utility** softkey, select **Function** in the bottom menu, select **Adjust** in the left menu, select **Self Cal** in the bottom menu; run the program after everything is ready.

Introduction to the Vertical System

As shown in *Figure 3-10*, there are a few of buttons and knobs in **Vertical Controls**. Press one of the channel buttons **CH1**, **CH2** to open the corresponding channel menu, and press again to turn off the channel.

If you want to set the vertical position and vertical scale of a channel, please press CH1, CH2 at first to select the desired channel. Then turn the **A** or **B** knob to set the values.

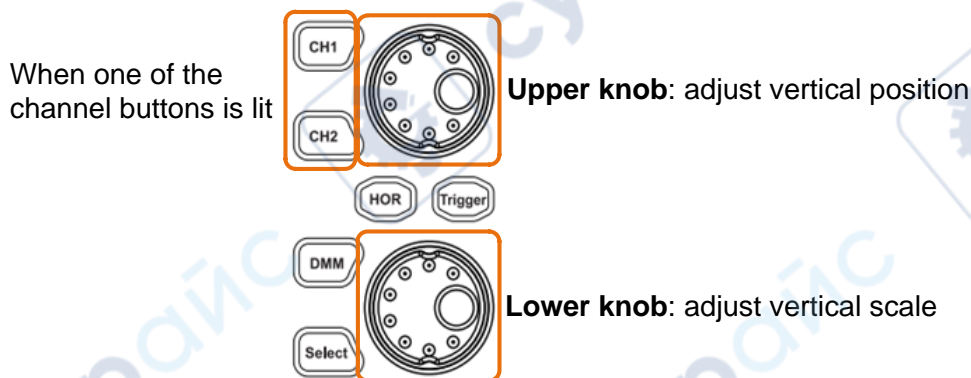

Figure 3-10 Vertical Control

The following practices will gradually direct you to be familiar with the using of the vertical setting.

1. Press **CH1**, **CH2** panel button to select the desired channel.
2. When one of the channel buttons is lit, you can use the **A** knob to show the selected channel waveform in the center of the waveform window. The **A** knob functions the regulating of the vertical display position of the selected channel waveform. Thus, when the **A** knob is rotated, the pointer of the earth datum point of the selected channel is directed to move up and down following the waveform, and the position message at the center of the screen would change accordingly.

Measuring Skill

If the channel is under the DC coupling mode, you can rapidly measure the DC

component of the signal through the observation of the difference between the wave form and the signal ground.

If the channel is under the AC mode, the DC component would be filtered out. This mode helps you display the AC component of the signal with a higher sensitivity.

Vertical offset back to 0 shortcut key

Turn the **A** knob to change the vertical display position of the selected channel, and push the **A** knob to set the vertical display position back to 0 as a shortcut key, this is especially helpful when the trace position is far out of the screen and want it to get back to the screen center immediately.

3. Change the Vertical Setting and Observe the Consequent State Information Change.

With the information displayed in the status bar at the bottom of the waveform window, you can determine any changes in the channel vertical scale factor.

Turn the **B** knob and change the "Vertical Scale Factor (Voltage Division)" of the selected channel, it can be found that the scale factor of the selected channel in the status bar has been changed accordingly.

Introduction to the Horizontal System

Shown as *Figure 3-11*, there are a button and two knobs in the **Horizontal Controls**. The following practices will gradually direct you to be familiar with the setting of horizontal time base.

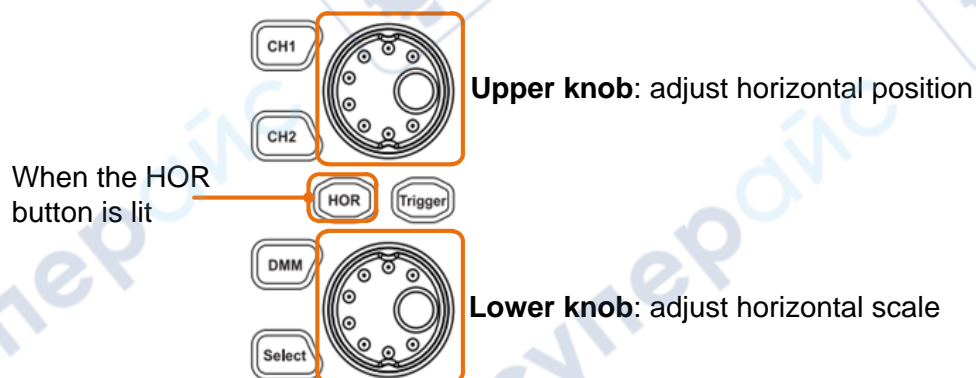

Figure 3-11 Horizontal Control

1. When the **HOR** button is lit, push the **HOR** button to switch between the normal mode and the wave zoom mode.
2. When the **HOR** button is lit, turn the **B** knob to change the horizontal time base setting and observe the consequent status information change. Turn the **B** knob to change the horizontal time base, and it can be found that the **Horizontal Time Base** displayed in the status bar changes accordingly.
3. When the **HOR** button is lit, use the **A** knob to adjust the horizontal position of the signal in the waveform window. The **A** knob is used to control the triggering

displacement of the signal or for other special applications. If it is applied to triggering the displacement, it can be observed that the waveform moves horizontally with the knob when you rotate the **A** knob.

Triggering displacement back to 0 shortcut key

Turn the **A** knob to change the horizontal position of channel and push the **A** knob to set the triggering displacement back to 0 as a shortcut key.

Introduction to the Trigger System

As shown in *Figure 3-12*, there are one knob and one button make up **Trigger Controls**. The following practices will direct you to be familiar with the setting of the trigger system gradually.

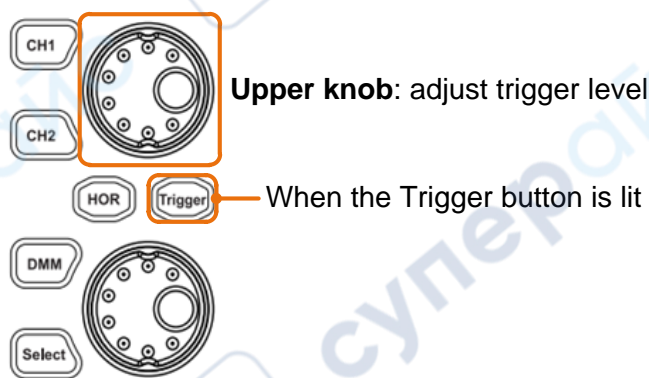







Figure 3-12 Trigger Control Zone

1. Click the  icon on the right bottom of the display area, click **Trig Menu** to call out the trigger menu in the bottom. The trigger setting can be changed.
2. When the **Trigger** button is lit, use the **A** knob to change the trigger level setting. By turning the **A** knob, the trigger indicator in the screen will move up and down. With the movement of the trigger indicator, it can be observed that the trigger level value displayed in the screen changes accordingly.
Note: Turning the **A** knob can change trigger level value and it is also the hotkey to set trigger level as the vertical mid point values of the amplitude of the trigger signal.
3. Click the **Ready** on the left top of the display area to force a trigger signal, which is mainly applied to the "Normal" and "Single" trigger modes.

Touchscreen Controls

You can control the oscilloscope by different gestures. The touchable icon at the top right of the screen is used to enable () or disable () the touchscreen controls. The instruction of touchscreen controls is as below.

- **Run/Stop:** Click the  or  on the left top of the display area to run or stop the

waveform sampling.

- **Force trigger:** Click the **Ready** on the left top of the display area to force a trigger signal, which is mainly applied to the "Normal" and "Single" trigger modes.
- **Autoset:** Click the **A** on the left top of the display area to auto set.
- **Select a menu item:** Touch the menu items in the bottom menu, or in the right menu, or in the left menu.
- **Switch menu items:** If there are options that can be switched on the menu, you can repeatedly touch the area of the menu item to switch, or push the corresponding button to switch. See figure below:



Press repeatedly to switch the options

- **Adjust value on the menu item:**

Click to increase the value of cursor position

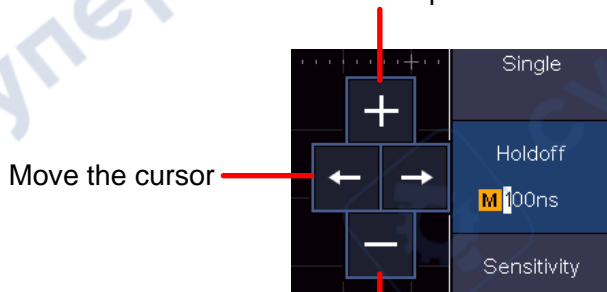

Move the cursor

Click to decrease the value of cursor position

- **Scroll the list:** If there is a scroll bar in the left menu, you can swipe up and down to scroll the list.
- **Touchable menu pane:** Click the **Home** icon on the right bottom of the display area, a menu will be shown. Click to enter the corresponding function menu.

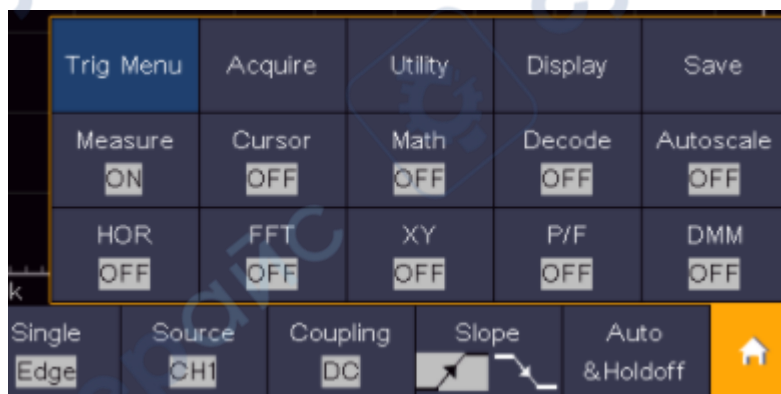

When **OFF** is shown, click to turn on the function, and enter the menu.

3.Quick Start

When **ON** is shown and unselected, click to enter the menu, click again to turn off.

- **Set the channel status:** Click the channel on the left bottom of the display area, you can turn on, select or turn off the channel. You can also touch the channel pointer on the left side of the display area to make it in selected state.



- **Set the horizontal and vertical position**

Click in the area as shown in the figure below, the **P** icon will appear. Click anywhere outside the icon to hide it.

Note: Swipe up/down or left/right in this area, you can make the icon appear and control it.

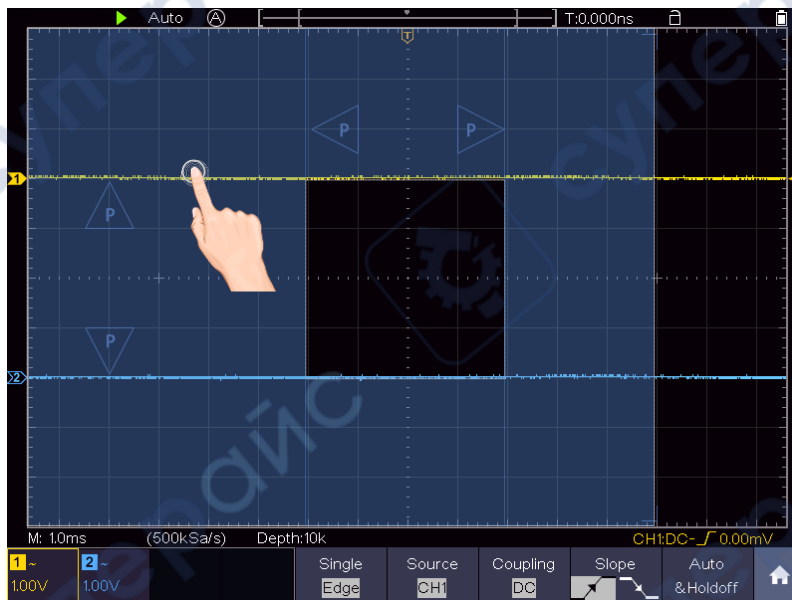

When the **P** icon appears, in the full screen, swipe left/right to control the horizontal position, swipe up/down to control the vertical position of the selected channel.

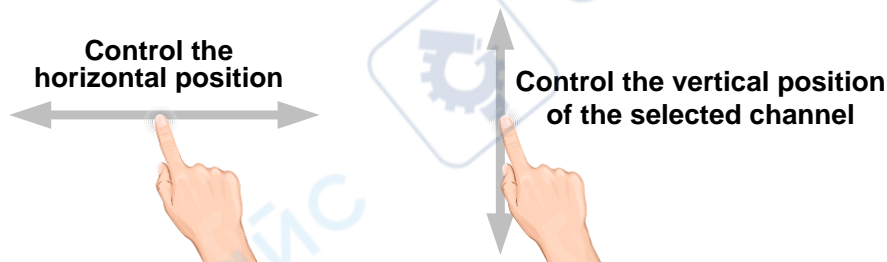

Click the **P** icon to fine-tune, long-press to adjust continuously.



- **Set the trigger level**

Click in the area as shown in the figure below, the **L** icon will appear. Click anywhere outside the icon to hide it.

Note: Swipe up/down in this area, you can make the icon appear and control it.

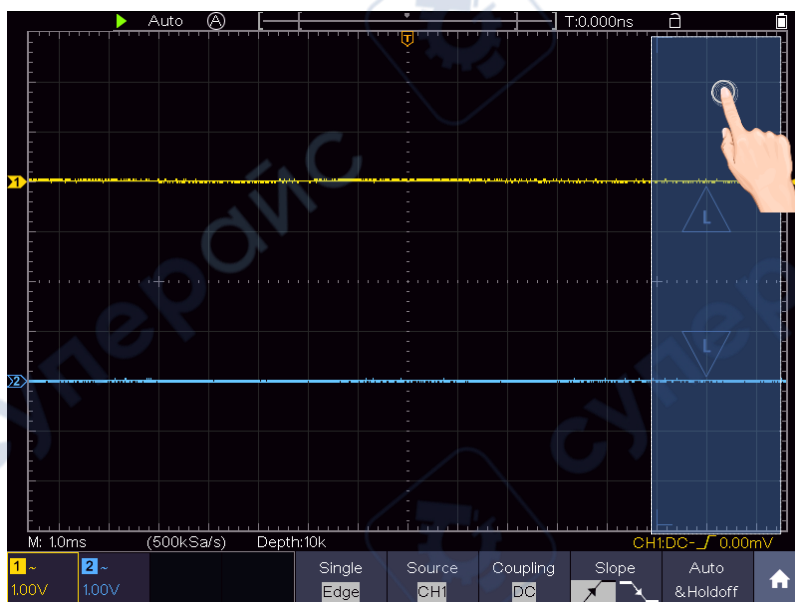

When the **L** icon appears, in the full screen, swipe up/down to control the trigger level of the source in the trigger menu.

Click the **L** icon to fine-tune, long-press to adjust continuously.

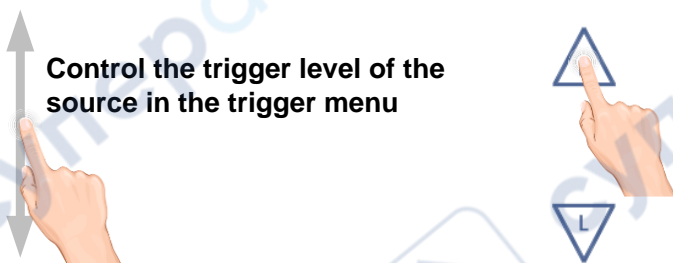

Control the trigger level of the source in the trigger menu

- **Set the time base and the voltage division**

Click in the area as shown in the figure below, the **M** and **V** icons will appear. Click anywhere outside the icon to hide it.

Note: Swipe up/down or left/right in this area, you can make the icon appear and control it.

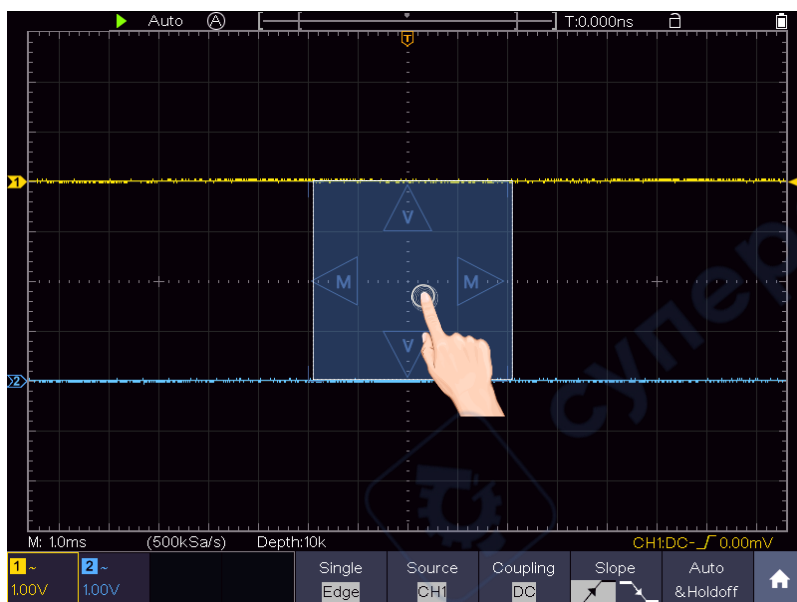

When the **M** and **V** icons appear, in the full screen, swipe left/right to change the time base, swipe up/down to change the voltage division of the selected channel. Click the icons to fine-turn, long-press to adjust continuously.

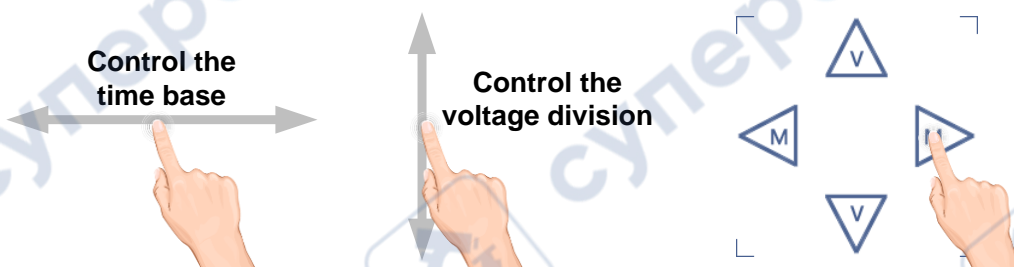

In the full screen, pinch and spread horizontally to change the time base; pinch and spread vertically to change the voltage division of the selected channel.



● **Measure with Cursors**

Click nearby a cursor line as shown in the figure below, the line will be selected, and the **C** icon will appear. Click anywhere outside the icon to hide it.

Note: Swipe in this area, you can make the icon appear and control it.

3.Quick Start

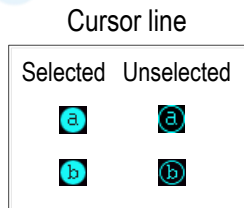
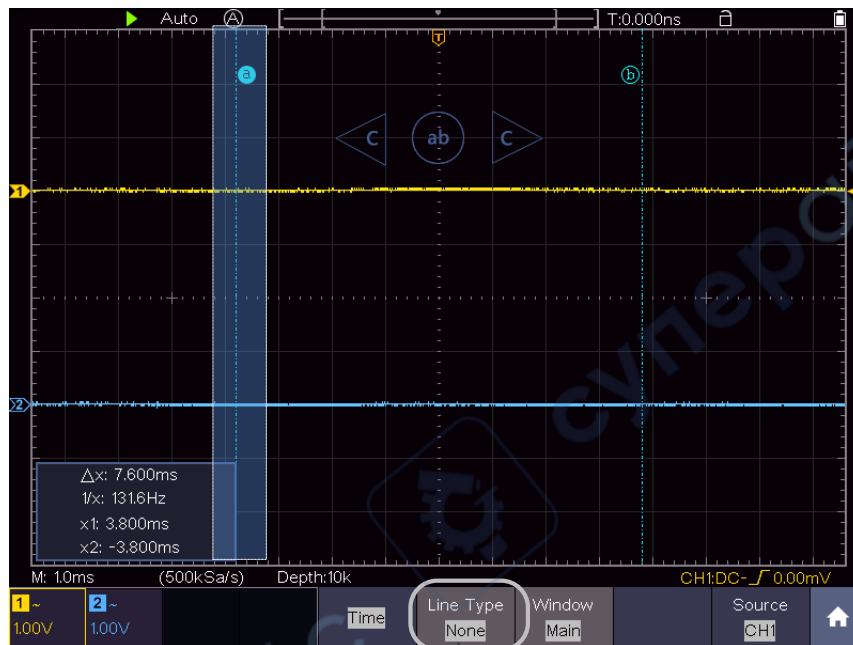

Switch horizontal or vertical lines
If vertical lines are selected, drag up and down.

When the **C** icon appears, in the full screen, swipe left/right to move the selected line. Click the direction buttons of the **C** icon to fine-tune, long-press to move continuously. Click the center "ab" button to select a, b, or a&b.

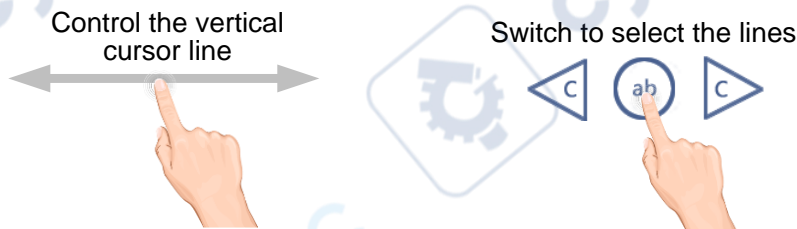

How to Measure Automatically

Click the icon on the right bottom of the display area, click **Measure** to display the menu for the settings of the Automatic Measurements. At most 8 types of measurements could be displayed on the bottom left of the screen.

The oscilloscopes provide 39 parameters for auto measurement, including Period, Frequency, Mean, PK-PK, RMS, Max, Min, Top, Base, Amplitude, Overshoot, Preshoot, Rise Time, Fall Time, +PulseWidth, -PulseWidth, +Duty Cycle, -Duty Cycle, Screen Duty, FRR, FRF, FFR, FFF, LRR, LRF, LFR, LFF, Delay A→B $\overline{\Psi}$, Delay A→B $\overline{\Phi}$, Cycle RMS, Cursor RMS, Phase A→B $\overline{\Psi}$, Phase A→B $\overline{\Phi}$, +PulseCount, -PulseCount, RiseEdgeCnt, FallEdgeCnt, Area, and Cycle Area.

E.g. Measure the period, the frequency of the CH1, following the steps below:

1. Click the icon, click **Measure** to show the automatic measurement function

menu.



2. Select **Add** in the bottom menu.
3. In the left Type menu, select **Period**.
4. In the right menu, select **Source** as **CH1**.
5. In the right menu, select **Add**. The period type is added.
6. In the left Type menu, select **Frequency**.
7. In the right menu, select **Source** as **CH1**.
8. In the right menu, select **Add**. The frequency type is added.

The measured value will be displayed at the bottom left of the screen automatically.

How to Use Autoscale

This is a very useful function for first time users to carry out a simple and quick test on the input signal. The function is applied to follow-up signals automatically even if the signals change at any time. Autoscale enables the instrument to set up trigger mode, voltage division and time scale automatically according to the type, amplitude and frequency of the signals.

E.g. If you want to measure the signal, you can do as the follows:

1. Click the  icon, click **Autoscale** to turn on. The function menu will appear.
2. In the bottom menu, Select **Mode**. In the right menu, select .
3. In the bottom menu, Select **Wave**. In the right menu, select .

4. Communication with PC

The oscilloscope supports communications with a PC through USB, LAN port or Wi-Fi. You can use the Oscilloscope communication software to store, analyze, display the data and remote control.

To learn about how to operate the software, you can push F1 in the software to open the help document.

Here is how to connect with PC. First, install the Oscilloscope communication software on the supplied CD. Then there are several ways of connection to choose from.

Using USB Port

- (1) **Connection:** Use a USB data cable to connect the **USB Device port** in the right panel of the oscilloscope to the USB port of a PC.
- (2) **Install the driver:** Run the Oscilloscope communication software on PC, push F1 to open the help document. Follow the steps of title "**I. Device connection**" in the document to install the driver.

- (3) **Port setting of the software:** Run the Oscilloscope software; click "Communications" on the menu bar, choose "Ports-Settings", in the setting dialog, choose "Connect using" as "USB". After connect successfully, the connection information in the bottom right corner of the software will turn green.

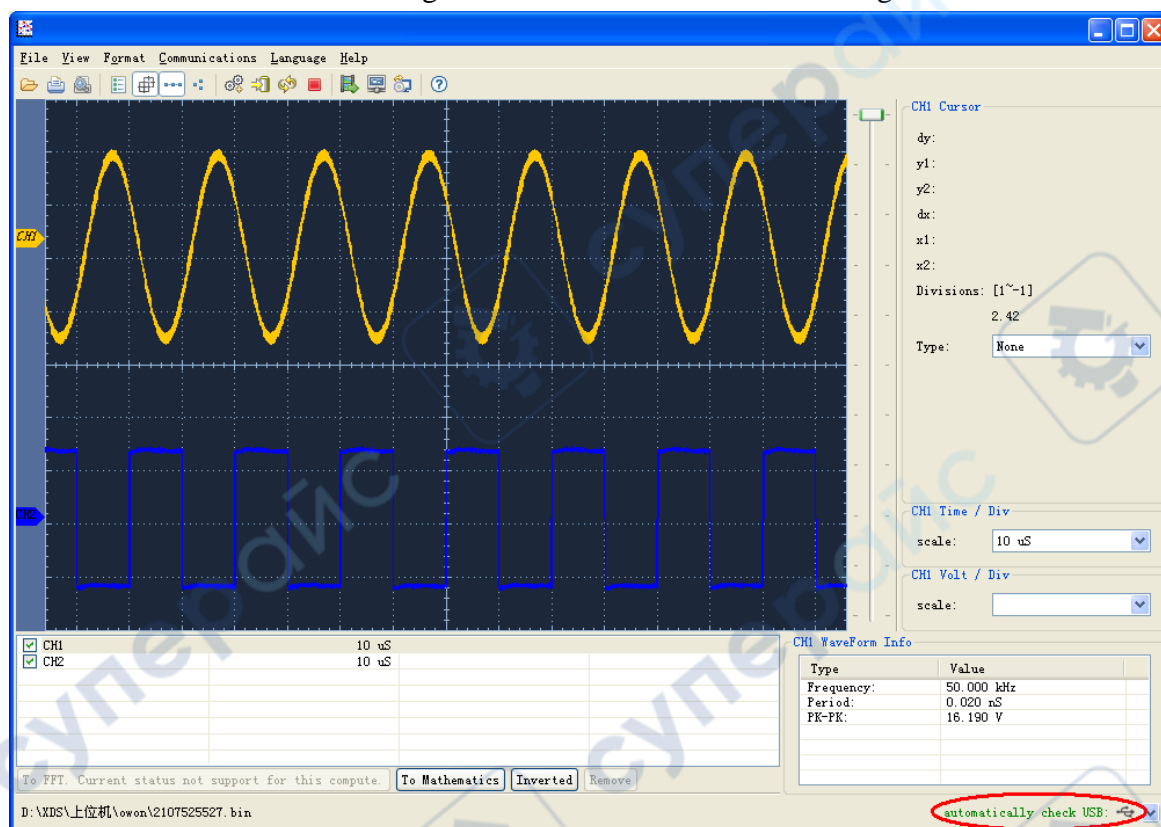

Figure 4-1 Connect with PC through USB port

Using LAN Port

Connect directly

- (1) **Connection.** Plug in the LAN cable to the LAN port in the right panel of the oscilloscope; plug the other end into the LAN interface of the computer.
- (2) **Set the network parameters of the computer.** Since the oscilloscope can not support obtaining an IP address automatically, you should assign a static IP address. Here we set the IP address to 192.168.1.71.

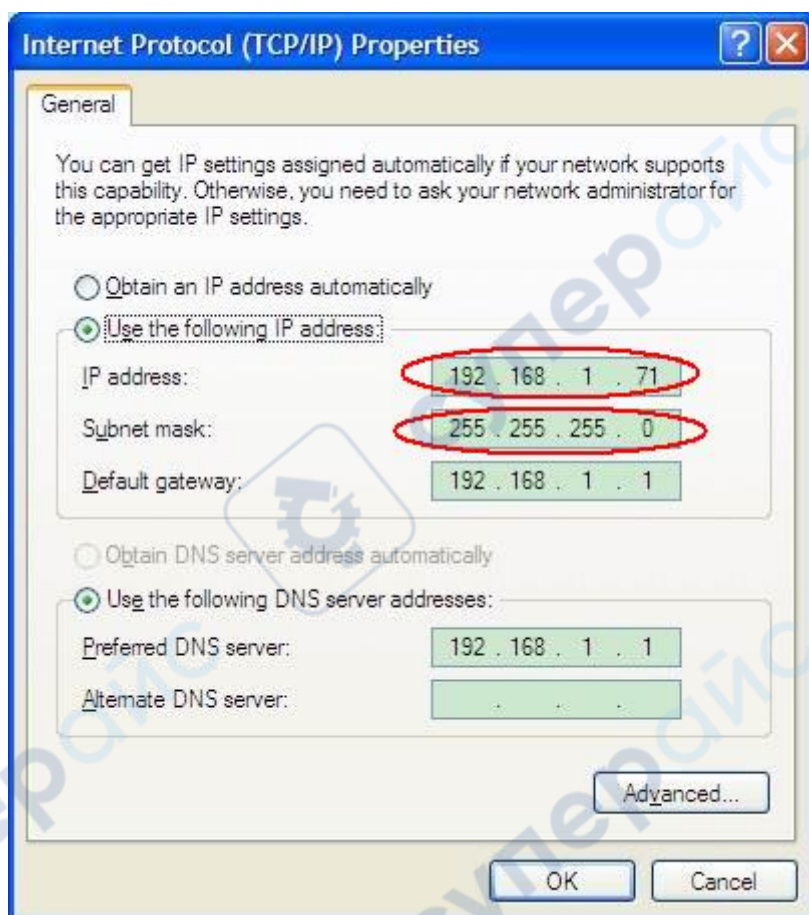

Figure 4-2 Set the network parameters of the computer

- (3) **Set the network parameters of the Oscilloscope Software.** Run the software on the computer; choose the "Ports-settings" of the "Communications" menu item. Set "Connect using" to LAN. About the IP, the first three bytes is same as the IP in the step (2), the last byte should be different. Here, we set it to 192.168.1.72. The range of the port value is 0 - 4000, but the port which under 2000 is always used, so it is suggested to set it to the value above 2000. Here, we set it to 3000.

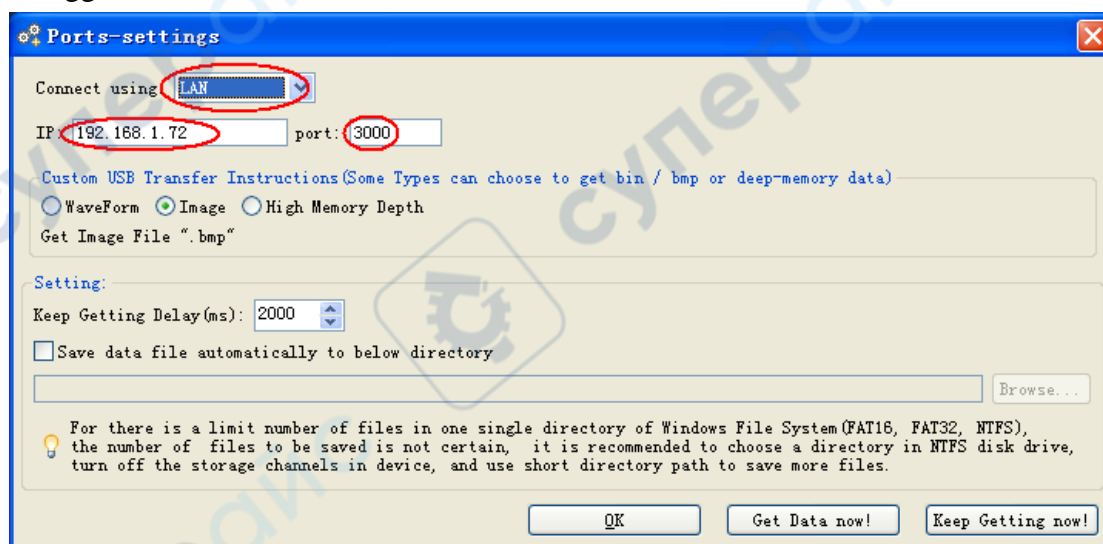

Figure 4-3 Set the network parameters of the Oscilloscope Software

- (4) **Set the network parameters of the oscilloscope.** In the oscilloscope, click the 

icon, click **Utility**. Select **Function** in the bottom menu. Select **LAN Set** in the left menu. In the bottom menu, set the **Type** item as **LAN**, and select **Set**. In the right menu, set **IP** and **Port** to the same value as the "Ports-settings" in the software in step (3). Select **Save set** in the bottom menu, it prompts "Reset to update the config". After resetting the oscilloscope, if you can get data normally in the oscilloscope software, the connection is successful.

Set	
IP	
M 192	168
1	72
Port	
3000	
Gateway	
192	168
1	1
Phy addr	
F3	49
12	B7
79	4
Subnet mask	
255	255
255	0

Figure 4-4 Set the network parameters of the oscilloscope

Connect through a router

- (1) **Connection.** Use a LAN cable to connect the oscilloscope with a router, the LAN port of the oscilloscope is in the right panel; the computer should be connected to the router too.
- (2) **Set the network parameters of the computer.** Since the oscilloscope can not support obtaining an IP address automatically, you should assign a static IP address. The Default gateway and Subnet mask should be set according to the router. Here we set the IP address to 192.168.1.71, Subnet mask is 255.255.255.0, Default gateway is 192.168.1.1.

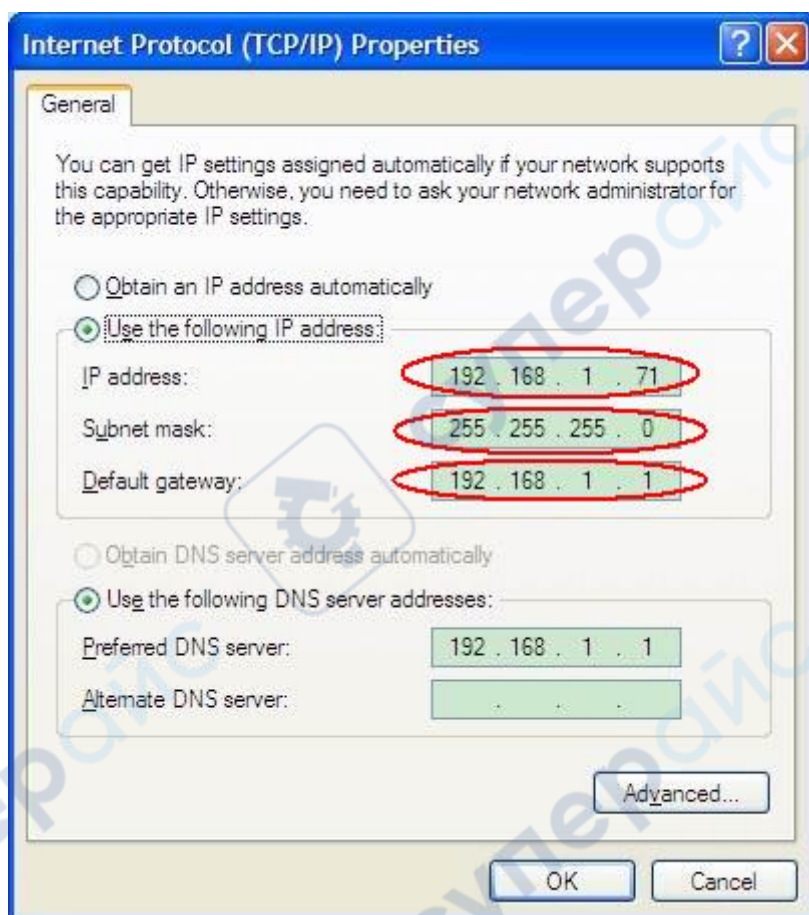

Figure 4-5 Set the network parameters of the computer

- (3) **Set the network parameters of the Oscilloscope Software.** Run the software on the computer; choose the "Ports-settings" of the "Communications" menu item. Set "Connect using" to LAN. About the IP, the first three bytes is same as the IP in the step (2), the last byte should be different. Here, we set it to 192.168.1.72. The range of the port value is 0 - 4000, but the port which under 2000 is always used, so it is suggested to set it to the value above 2000. Here, we set it to 3000.

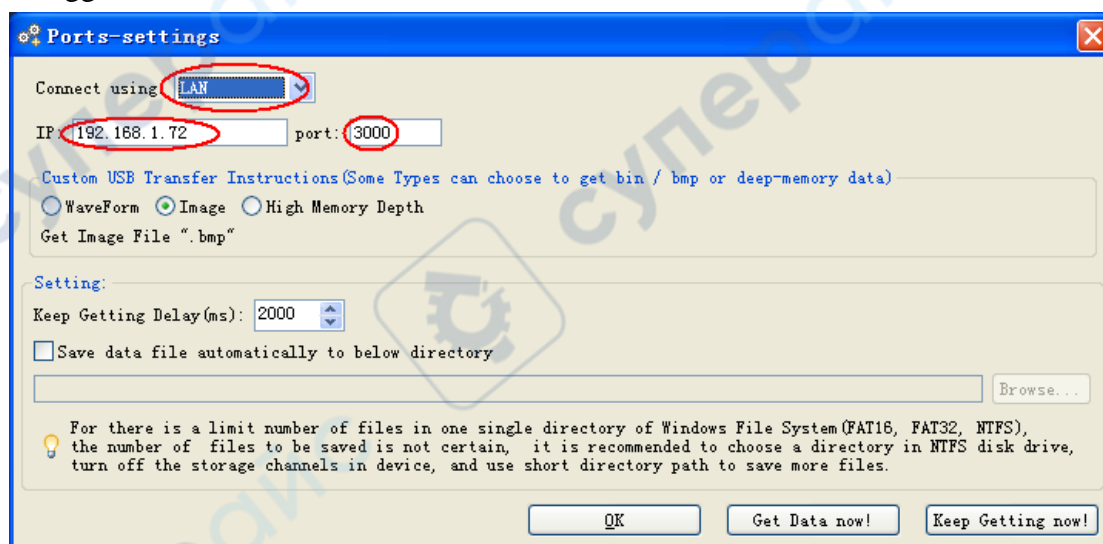

Figure 4-6 Set the network parameters of the Oscilloscope Software

- (4) **Set the network parameters of the oscilloscope.** In the oscilloscope, click the 

icon, click **Utility**. Select **Function** in the bottom menu. Select **LAN Set** in the left menu. In the bottom menu, set the **Type** item as **LAN**, and select **Set**. In the right menu, set **IP** and **Port** to the same value as the "Ports-settings" in the software in step (3). The Gateway and Subnet mask should be set according to the router. Select **Save set** in the bottom menu, it prompts "Reset to update the config". After resetting the oscilloscope, if you can get data normally in the oscilloscope software, the connection is successful.

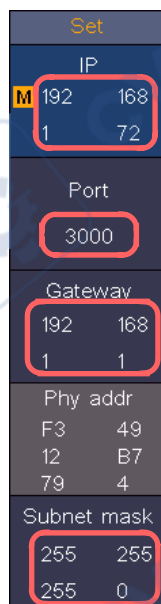



Figure 4-7 Set the network parameters of the oscilloscope

Using Wi-Fi to Connect with PC (Optional)

Connect with PC as Wi-Fi Access Point

PC should support Wi-Fi.

- (1) **Set the oscilloscope.** In the oscilloscope, click the  icon, click **Utility**. Select **Function** in the bottom menu. Select **LAN Set** in the left menu. In the bottom menu, set the **Type** item as **WIFI-AP**, and select **Set** in the bottom menu.
- (2) In the right menu, select **SSID**, a keyboard will pop up. You can turn and push the **M** knob, or touch the keyboard (if the LCD is touchscreen) to set the access point name.
- (3) In the right menu, select **Encryption**, push again to set the type. **Open** type needs no password. **WEP** or **WPA** type need to set the password. You can select **WPA**. In the right menu, select **Password**, use the keyboard to set the WI-FI password (8 to 32 characters).
- (4) In the right menu, select **IP:PORT**, **IP** is fixed by the oscilloscope, and can not be edited. Here IP is 192.168.1.1. Turn the **M** knob to set the **PORT**. Here, we set it to 3000.
- (5) After setting, select **ON** in the **Status** menu. The  icon appears on the top right of the screen.

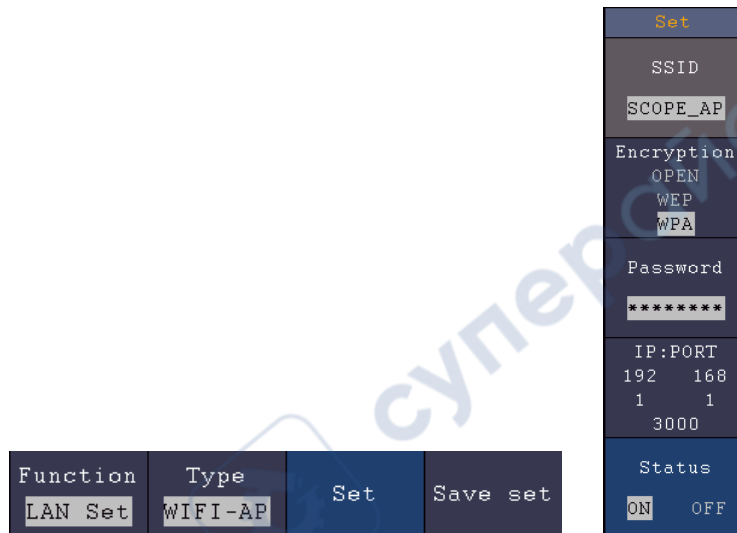

- (6) Select **Save set** in the bottom menu to save current settings.
- (7) **Set Wi-Fi connection on PC.** Enter the WI-FI settings on PC, select the oscilloscope access point to connect, enter the set password.

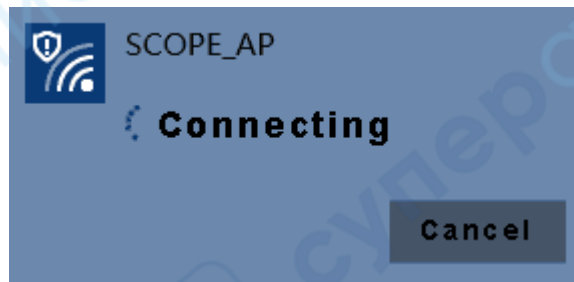

- (8) **Set the network parameters of the Oscilloscope Software.** Run the software on the computer; choose the "Ports-settings" of the "Communications" menu item. Set "Connect using" to LAN. Set **IP** and **Port** to the same value in the oscilloscope in the step (4). If you can get data normally, the connection is successful.

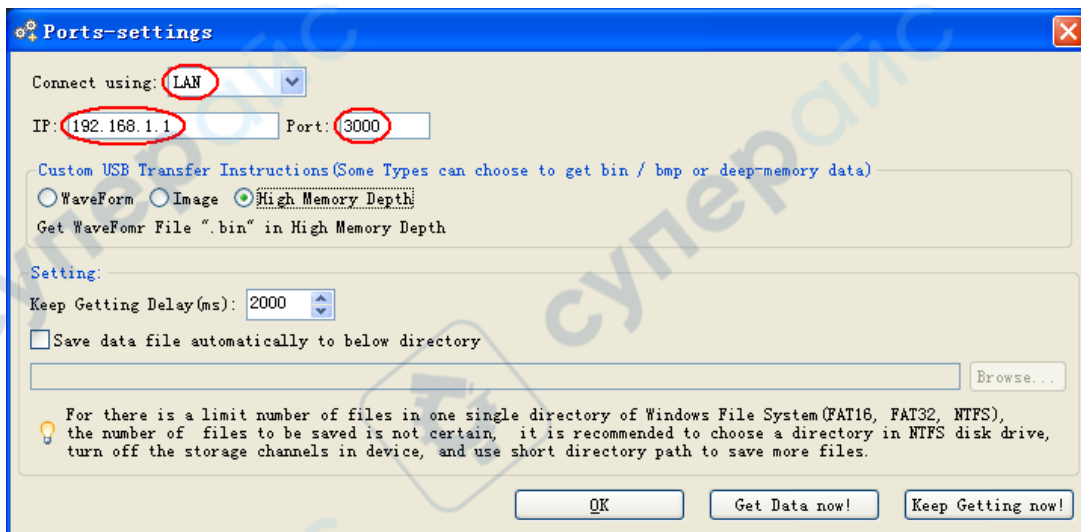



Figure 4-8 Set the network parameters of the Oscilloscope Software

Connect with PC as Wi-Fi Station

The oscilloscope and PC should be on the same network (LAN).

- (1) In the oscilloscope, push the **Utility** button. Select **Function** in the bottom menu.

Select **LAN Set** in the left menu. In the bottom menu, set the **Type** item as **WIFI-STA**, and select **Set** in the bottom menu.

- (2) In the right menu, select **SSID**, a keyboard will pop up. Input the name of the Wi-Fi hotspot. You can turn and push the **M** knob, or touch the keyboard (if the LCD is touchscreen).
- (3) In the right menu, select **Encryption**, push to set the Encryption type of the Wi-Fi hotspot. **Open** type needs no password. **WEP** or **WPA** type need to input the password. In the right menu, select **Password**, use the keyboard to input the Wi-Fi hotspot password.
- (4) In the right menu, select **IP:PORT**, Turn the **M** knob to set the **PORT**. Here, we set it to 3000.
- (5) After setting, select **ON** in the **Status** menu. The value of **IP** is displayed in **IP:PORT** menu. Here IP is 10.1.1.126. A changing icon  appears on the top right of the screen.

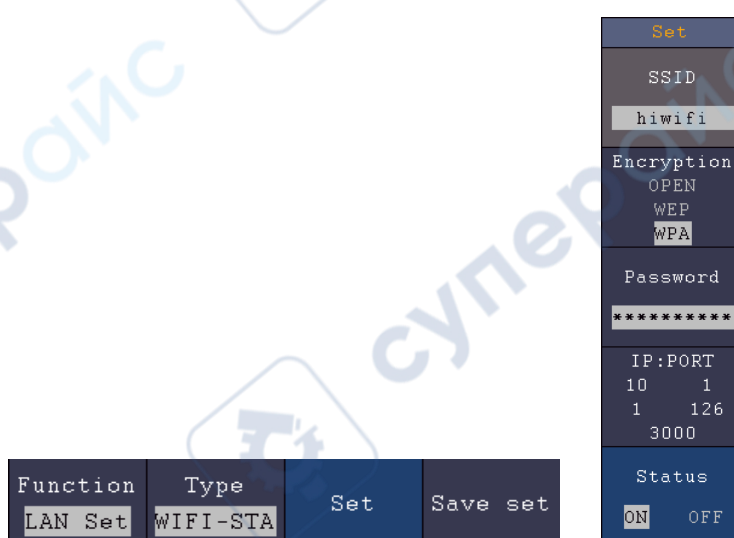

- (6) Select **Save set** in the bottom menu to save current settings.
- (7) **Set the network parameters of the computer.** Set IP in the computer, the first three bytes is same as the IP in the oscilloscope, the last byte should be different. Here, we set it to 10.1.1.123. The Default gateway and Subnet mask should be set according to the router.

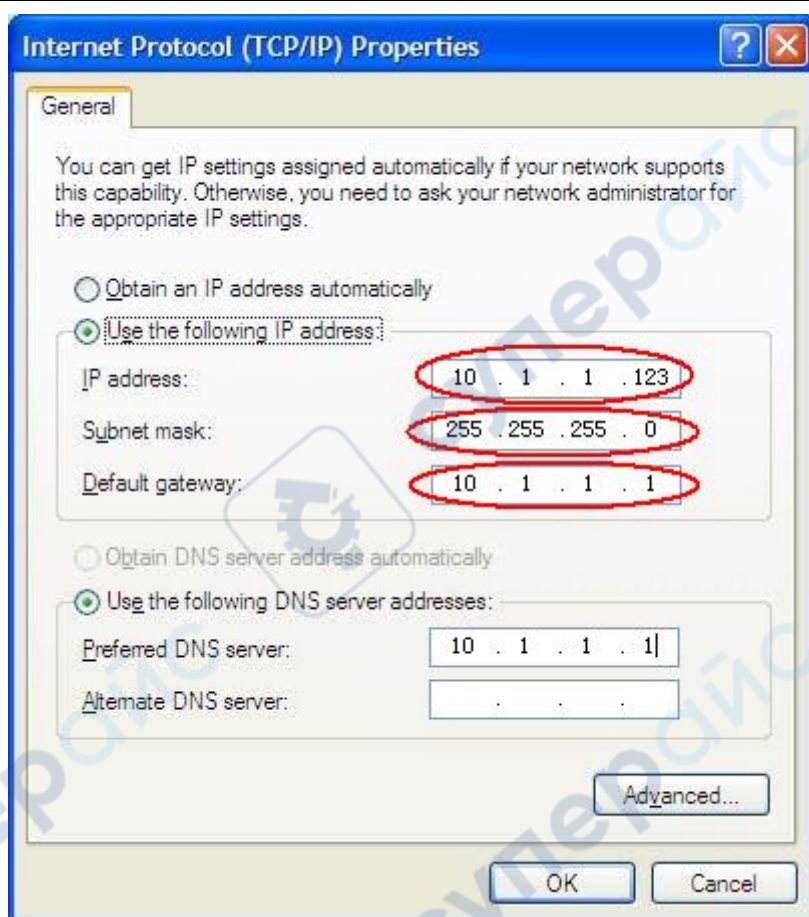

Figure 4-9 Set the network parameters of the computer

- (8) **Set the network parameters of the Oscilloscope Software.** Run the software on the computer; choose the "Ports-settings" of the "Communications" menu item. Set "Connect using" to LAN. Set **IP** and **Port** to the same value in the oscilloscope. If you can get data normally, the connection is successful.

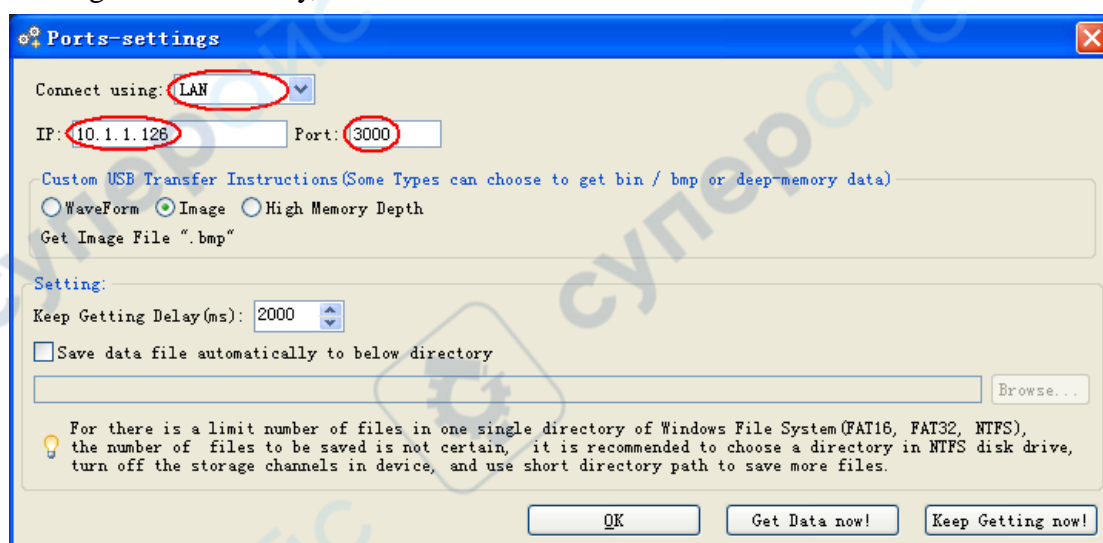

Figure 4-10 Set the network parameters of the Oscilloscope Software

5. Use the Multimeter

Input Terminals

The input terminals are on the Top of the oscilloscope.

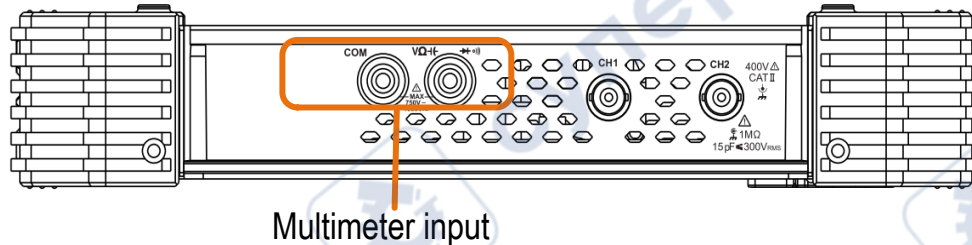

Figure 5-1 Multimeter Input Terminals

DMM Menu

DMM : Push **DMM** button on the front panel to enter/exit the multimeter function. The button backlight will be lighted when the multimeter function is enabled.

Select : Push **Select** button on the front panel to select the multimeter function menu.

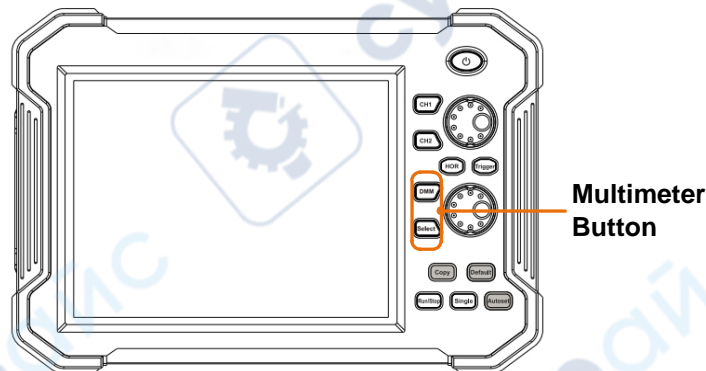

Figure 5-2 Multimeter Button

The bottom menu of multimeter is as below:

Menu	Setting	Description
Current	ACA	Measuring AC current
	DCA	Measuring DC current
Voltage	ACV	Measuring AC voltage
	DCV	Measuring DC voltage
R ∇ $\square \gg$ C		Measuring resistance
		Testing diode
		Testing for continuity
		Measuring capacitance
Hold	ON OFF	Freeze the display during measurement.
Configure	Relative	When making relative measurements, reading is the

5. Use the Multimeter

		difference between a stored reference value and the input signal.
Show Info ON OFF		Show/Hide the information window
Auto Range		Select auto range mode
Switch Range		Select manual range mode, press to switch range
Voltage mV V (Only for voltage measurement)		Select the Voltage range.

DMM Information Window

The Multimeter Information Window is displayed on the top right of the screen.

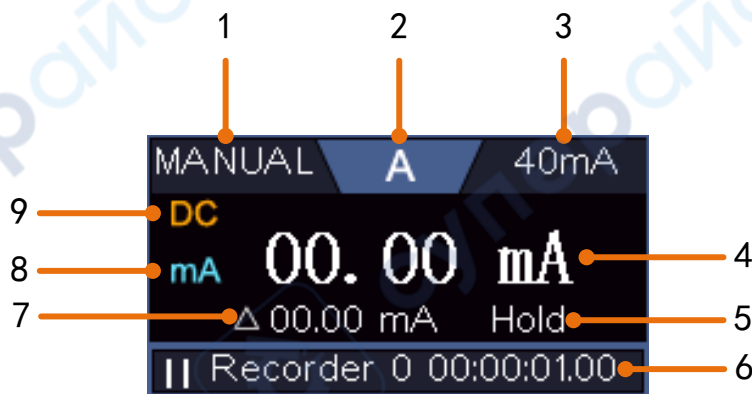

Figure 5-3 Multimeter Information Window

Description

- Manual/Auto range indicators, **MANUAL** refers to the measuring range in manual operation mode and **AUTO** refers to the measuring range in automatic operation mode.
- Measurement mode indicators:
 - A** ----- Current measurement
 - V** ----- Voltage measurement
 - R** ----- Resistance measurement
 - ∇ ----- Diode measurement
 - $\square \gg$ ----- Continuity test
 - C** ----- Capacitance measurement
3. Range.
4. Measurement display ("OL" is short for overload, indicates the reading exceeds the display range)
5. Data hold mode is enabled.

6. Multimeter recorder.
7. The reference value of the relative measurement.
8. Range of measuring current: mA or 10A.
9. AC or DC when measuring current or voltage.

6. Communication with Android Device via Wi-Fi (Optional)

The oscilloscope supports communications with Android based smart device via Wi-Fi. You can use the free application software on the Android based smart devices to view the waveform synchronously, perform remote control, the waveform can be saved as image (BMP, PNG) or file (CSV, BIN), or shared via installed sharing apps.

System Requirements of Mobile Devices

- Android Versions: 4.0 and above

How to Connect

In Wi-Fi settings of the oscilloscope, there are two connection types. One is WIFI-AP (Access Point), the oscilloscope is set as Wi-Fi access point, the Android device can be connected to it directly. The other type is WIFI-STA (Station), the oscilloscope is set as Wi-Fi station. The Android device can be connected to it through a Wi-Fi hotspot.

Connect with APP as Wi-Fi Access Point

- (1) In the oscilloscope, push the **Utility** button. Select **Function** in the bottom menu. Select **LAN Set** in the left menu. In the bottom menu, set the **Type** item as **WIFI-AP**, and select **Set** in the bottom menu.
- (2) In the right menu, select **SSID**, a keyboard will pop up. You can turn and push the **M** knob, or touch the keyboard (if the LCD is touchscreen) to set the access point name.
- (3) In the right menu, select **Encryption**, push again to set the type. **Open** type needs no password. **WEP** or **WPA** type need to set the password. You can select **WPA**. In the right menu, select **Password**, use the keyboard to set the Wi-Fi password (8 to 32 characters).
- (4) In the right menu, select **IP:PORT**, **IP** is fixed by the oscilloscope, and can not be edited. Turn the **M** knob to set the **PORT**.
- (5) After setting, select **ON** in the **Status** menu. The  icon appears on the top right of the screen.

6.Communication with Android Device via Wi-Fi (Optional)

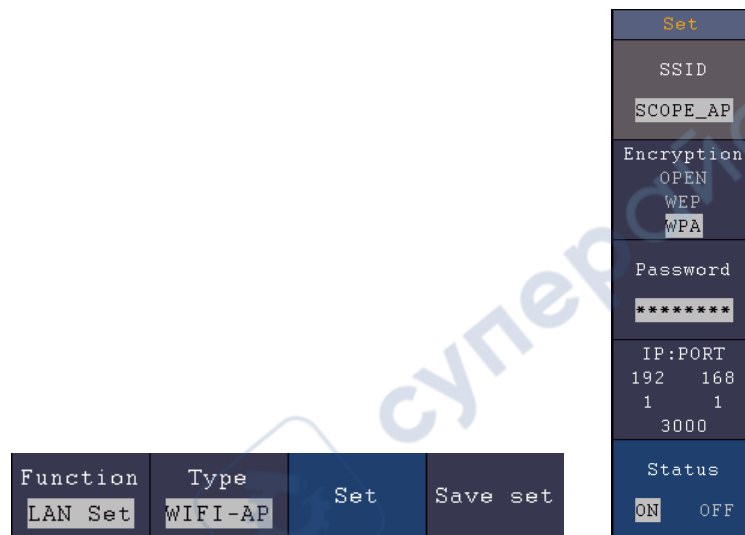

- (6) Select **Save set** in the bottom menu to save current settings.
- (7) In Android device, enter the Wi-Fi settings, select the oscilloscope access point to connect, enter the set password.

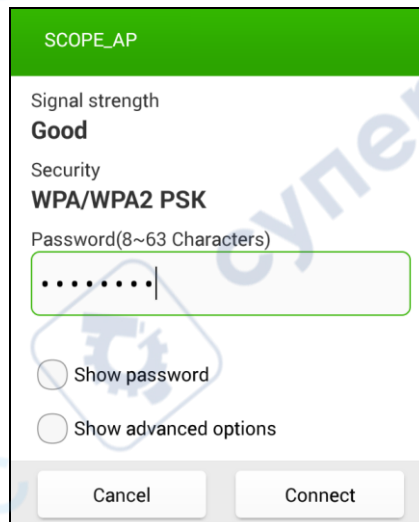

- (8) In Android device, launch the application.
- (9) Click **connect** on the left.

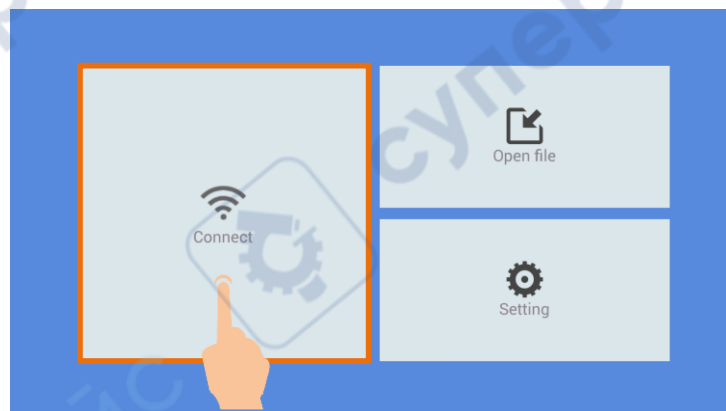

- (10) Set **IP** and **Port** to the same value as the setting in the oscilloscope. Click **Confirm** to connect. Click **History** to recall the history settings.

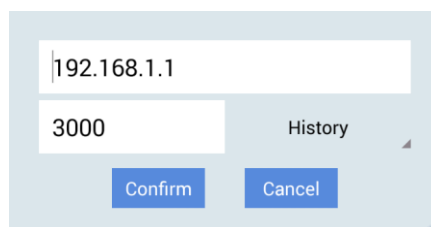

Connect with APP as Wi-Fi Station

- (1) In the oscilloscope, push the **Utility** button. Select **Function** in the bottom menu. Select **LAN Set** in the left menu. In the bottom menu, set the **Type** item as **WIFI-STA**, and select **Set** in the bottom menu.
- (2) In the right menu, select **SSID**, a keyboard will pop up. Input the name of the Wi-Fi hotspot. You can turn and push the **M** knob, or touch the keyboard (if the LCD is touchscreen).
- (3) In the right menu, select **Encryption**, push to set the Encryption type of the Wi-Fi hotspot. **Open** type needs no password. **WEP** or **WPA** type need to input the password. In the right menu, select **Password**, use the keyboard to input the Wi-Fi hotspot password.
- (4) In the right menu, select **IP:PORT**, Turn the **M** knob to set the **PORT**.
- (5) After setting, select **ON** in the **Status** menu. The value of **IP** is displayed in **IP:PORT** menu. A changing icon  appears on the top right of the screen.

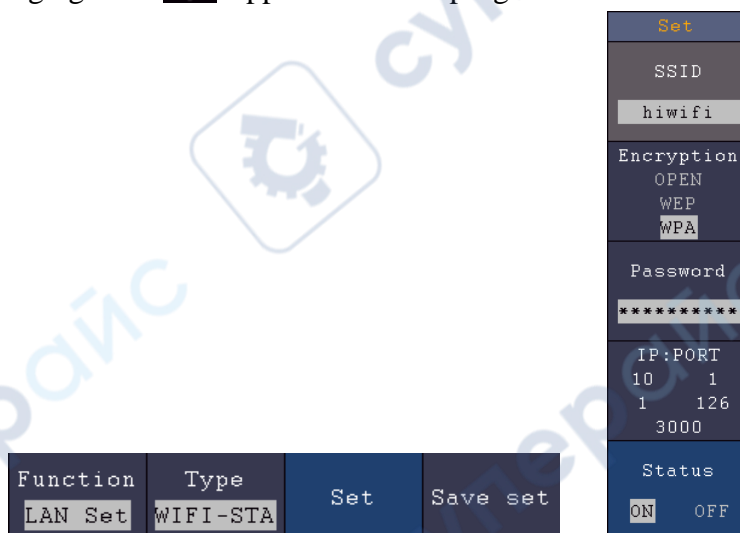

- (6) Select **Save set** in the bottom menu to save current settings.
- (7) In Android device, enter the Wi-Fi settings, select the oscilloscope access point to connect, enter the set password.

6.Communication with Android Device via Wi-Fi (Optional)

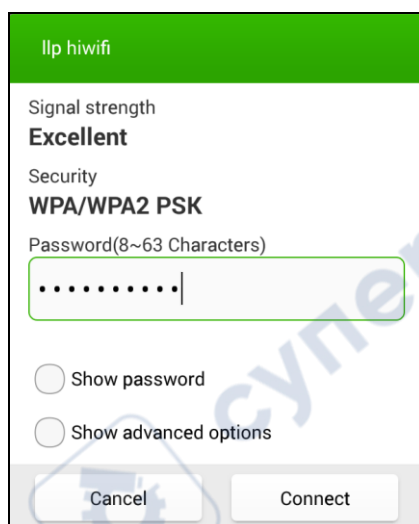

(8) In Android device, launch the application.

(9) Click **connect** on the left.

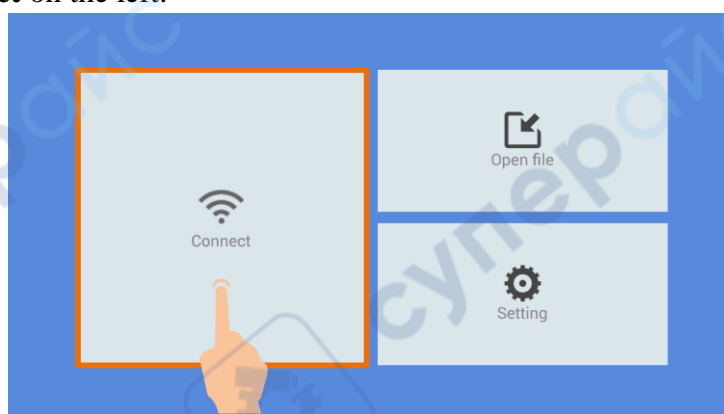

(10) Set **IP** and **Port** to the same value as the setting in the oscilloscope. Click **Confirm** to connect. Click **History** to recall the history settings.

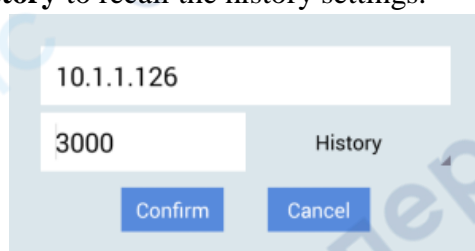

7. Appendix

Appendix A: Enclosure

(The accessories subject to final delivery.)

Standard Accessories:



Power Cord



AC-DC
Adapter



CD Rom



Quick Guide



Micro USB Cable



Probe Adjust



Probe Adjust



Stand Holder



BNC-SAM



Current Ext Module



Multimeter Lead

Options:



Bag

Appendix B: General Care and Cleaning

General Care

Do not store or leave the instrument where the liquid crystal display will be exposed to direct sunlight for long periods of time.

Caution: To avoid any damage to the instrument or probe, do not exposed it to any sprays, liquids, or solvents.

Cleaning

Inspect the instrument and probes as often as operating conditions require.

To clean the instrument exterior, perform the following steps:

1. Wipe the dust from the instrument and probe surface with a soft cloth. Do not make any scuffing on the transparent LCD protection screen when clean the LCD screen.
2. Disconnect power before cleaning your Oscilloscope. Clean the instrument with a wet soft cloth not dripping water. It is recommended to scrub with soft detergent or fresh water. To avoid damage to the instrument or probe, do not use any corrosive chemical cleaning agent.



Warning: Before power on again for operation, it is required to confirm that the instrument has already been dried completely, avoiding any electrical short circuit or bodily injury resulting from the moisture.

Appendix C: USB Disk Requirements

The supported format of the USB disk: FAT32 file system, allocation unit size cannot exceed 4K, mass storage USB disk is also supported. If the USB disk doesn't work properly, format it into the supported format and try again. To learn how to format the USB disk, please refer to the User Manual. You can get this manual from the supplied CD.

2020.09 V1.0.1